

BIRO®

**Known For Reliability
For Over 89 Years**



PRO-9

The **BIRO** Pro-9 Series Stands Alone for Versatility and Productivity

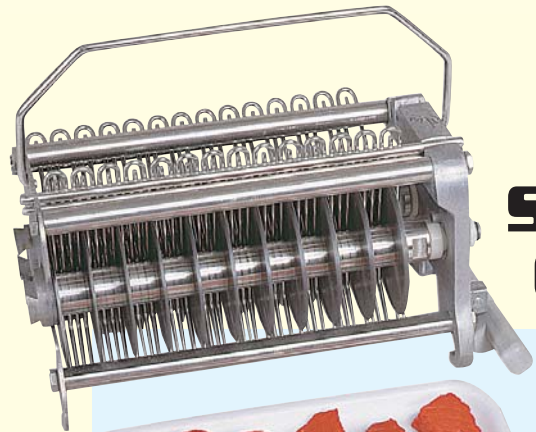

STRIP CUTTING

- Use a **BIRO** strip cutting group to make such diverse products as strips for stir fry or fajitas, julienne for salads, and beef jerky strips. Use two passes to make cubes for stew or soup meat. Cut your valuable production time significantly while making those value-added products your customers want.



- **BIRO** strip cutting groups are available in 1/4", 3/8", 9/16", 3/4", 1", 1 1/4", 1 9/16", and 2" strip widths. Choose the sizes which work best for you to help you merchandise less expensive cuts for higher profit.



Nothing surpasses the Pro-9 Tenderizer for versatility. Use the Pro-9 to tenderize, knit, score, cut strips, cut stew, and star punch. Merchandise less expensive, less tender cuts to create value-added products which add to your bottom line.



SCORING

- **BIRO** scoring rollers cut just the surface of the steak or patty, which creates an eye-appealing product which cooks quicker. Create a value-added product which can improve your gross profit by enabling you to profitably merchandise less expensive cuts.



- You can tailor your scoring roller set to the size of the product by choosing the blade diameter which works for you. Choose from 5 different sizes of gap between rollers to stretch or thicken your product so you get the mix of value-added products which makes the most profit for you.

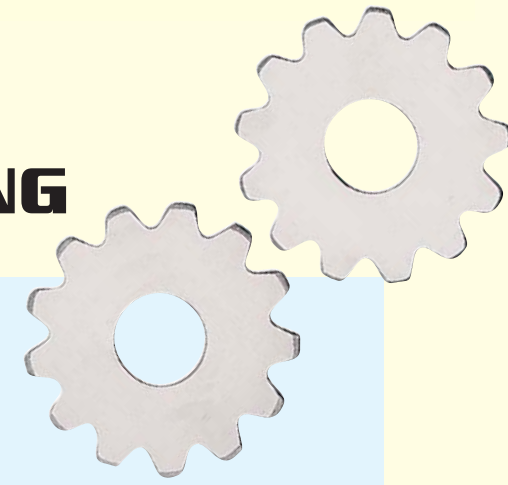

CUTLET TENDERIZING

- Designed specially for thin or delicate products such as veal, chicken breast, or squid, the cutlet tenderizer set gently pierces the product without tearing it. You can create value-added products such as veal scaloppine or veal parmigiana which will broaden your product mix and enhance your sales and profit.

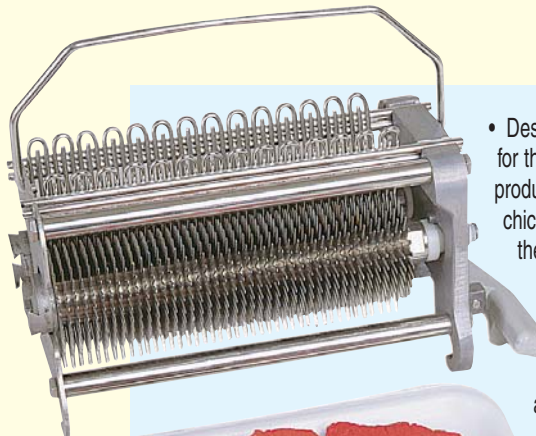

- Use the cutlet tenderizer set with the no charge optional 140 rpm roller speed. Attain maximum productivity while making value-added products.

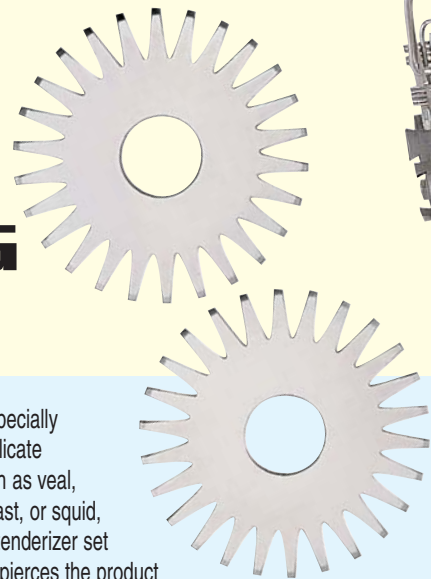

TENDERIZING/KNITTING

- **BIRO** standard tenderizer blades cut deep into the product to sever fiber and sinew. Two passes are all you need to create value-added product from less expensive, hard to merchandise cuts. Improve your product mix and gross profit and increase productivity.

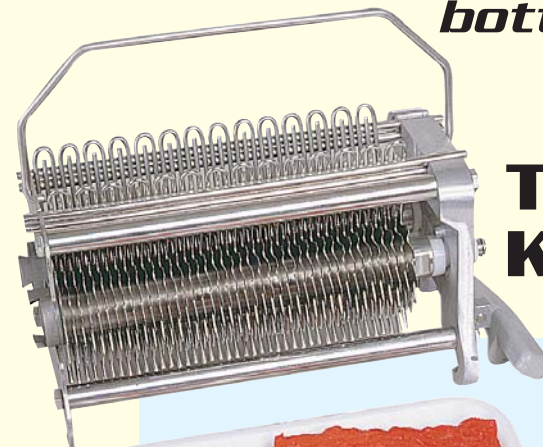

- You can turn your tenderizing set into a knitting set just by changing the position of the rear stripper. Take two smaller pieces of hard to merchandise meat and convert them into one value-added product.



STAR PUNCHING

- The **BIRO** star punching group uses 1/8" star rollers to punch lasting holes into the meat patty or steak to break down fiber. This makes the product more tender and reduces the cooking time of the product by up to 40%. Use the star punching group to merchandise those less expensive, less tender cuts as value-added products for higher profit.

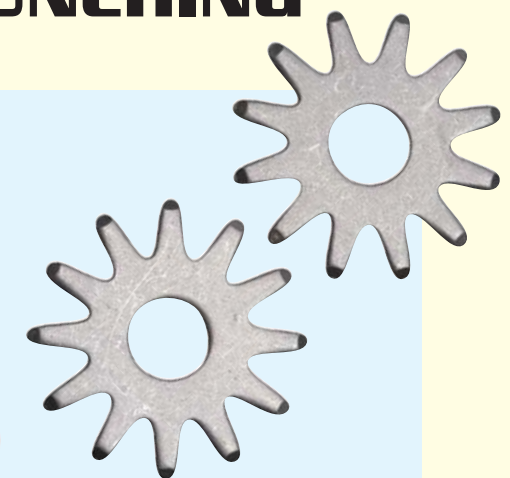
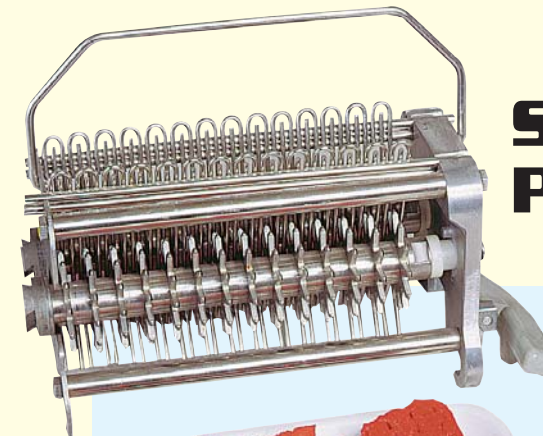



**Stands alone for quality
and value since 1921**

SPECIFICATIONS

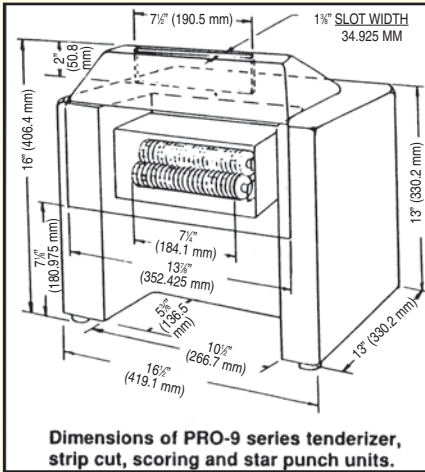

Dimensions of PRO-9 series tenderizer, strip cut, scoring and star punch units.

	PRO-9 SD	PRO-9 HD - 1/2 HP	PRO-9 HD - 3/4 HP
ELECTRICAL SUPPLY	115V, 1 PHASE – 5 FOOT – 3 WIRE CORD, 3 PRONG MOLDED, GROUNDED PLUG, 230V, 1 PHASE – 5 FOOT – 3 WIRE CORD, NO PLUG		
CASE	STAINLESS STEEL		
CASE TOP	STAINLESS STEEL		
CUTTING GROUPS	STAINLESS STEEL WITH STAINLESS STEEL SPACERS AND COMBS		
ROLLER SPEEDS	105 R.P.M. STANDARD	115 R.P.M. STANDARD 140 R.P.M. OPTIONAL – NO COST	
TRANSPARENT SAFETY COVER	LEXAN TRANSPARENT		
TRANSMISSION	OIL BATH GEAR BOX		
TRANSMISSION DRIVE	POLY FLEX DOUBLE-V BELT FIBER GEAR SYSTEM	POLY FLEX DOUBLE-V BELT STEEL GEAR SYSTEM	
SAFETY SWITCH	MOTOR SHUTS OFF WHEN SAFETY COVER IS RAISED		
STANDARD FEATURES	DUAL PURPOSE TENDERIZER/KNIT ASSEMBLY, CORD AND/OR PLUG (SEE ELECTRICAL) OPERATING AND SAFETY MANUAL		
OPTIONS (EC)	HEAVY DUTY RIGID SS COMBS, SS SAFETY COVER, CRADLE STORAGE CONTAINER, SS CART		
CERTIFICATIONS	N.S.F., U.S.D.A., U.L., C.S.A., C.F.I.A.		
WEIGHTS – APPROX. UNPACKED:	69 LBS. (31 KG.)	70 LBS. (32 KG.)	73 LBS. (33.1 KG.)
PACKED:	74 LBS. (33.6 KG.)	75 LBS. (34 KG.)	78 LBS. (35 KG.)
DIMENSIONS PACKED:	L = 20" (508 MM) X W = 20" (508 MM) X H = 19" (483 MM)		

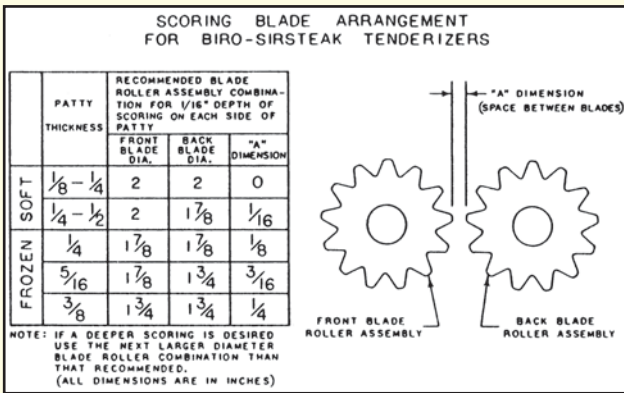

MOTORS

HP	KW	TYPE	VOLTS	AMPS	CYCLE	PH	STATUS
1/2SD	.38	TEFC DP	115/230	7.5/3.8	60	1	STD
1/2HD	.38	TEFC DP	115/230	7.5/3.8	60	1	STD
3/4HD	.56	TEFC DP	115/230	8.8/4.4	60	1	STD
1/2SD	.38	TEFC DP	115/230	7.5/3.8	50	1	EC
1/2HD	.38	TEFC DP	115/230	7.5/3.8	50	1	EC
3/4HD	.56	TEFC DP	115/230	8.8/4.4	50	1	EC

SD=STANDARD DUTY HD=HEAVY DUTY
STD=STANDARD TEFC DP=TOTALLY ENCLOSED
FAN COOLED, DRIP PROOF

STANDARD AND OPTIONAL CUTTING GROUPS		HOPPER TYPE REQUIRED	PRO-9 SD 1/2 HP	PRO-9 HD 1/2 HP	PRO-9 HD 3/4 HP
TA3130-50	CUTLET (TENDERIZING) CRADLE ASSEMBLY	SS	EC	EC	EC
TA3130	STD (TENDERIZING) CRADLE ASSEMBLY	L	STD	STD	STD
TA3130-9A	1/4" STEW-STRIP CRADLE ASSEMBLY	L	NA	EC	EC
TA3130-5A	3/8" STEW-STRIP CRADLE ASSEMBLY	L	NA	EC	EC
TA3130-4A	9/16" STEW-STRIP CRADLE ASSEMBLY	L	NA	EC	EC
TA3130-1A	3/4" STEW-STRIP CRADLE ASSEMBLY	L	EC	EC	EC
TA3130-14A	7/8" STEW-STRIP CRADLE ASSEMBLY	L	EC	EC	EC
TA3130-2A	1" STEW-STRIP CRADLE ASSEMBLY	L	EC	EC	EC
TA3130-3A	1 1/4" STEW-STRIP CRADLE ASSEMBLY	L	EC	EC	EC
TA3130-7A	1 9/16" STEW-STRIP CRADLE ASSEMBLY	L	EC	EC	EC
TA3130-8A	2" STEW-STRIP CRADLE ASSEMBLY	L	EC	EC	EC
TA3130-36	STAR ROLLER CRADLE ASSEMBLY	L	EC	EC	EC
TA3130-20	SCORING CRADLE ASSEMBLY, 0 ROLLER GAP	L	NA	EC	EC
TA3130-21	SCORING CRADLE ASSEMBLY, 1/16" ROLLER GAP	L	NA	EC	EC
TA3130-22	SCORING CRADLE ASSEMBLY, 1/8" ROLLER GAP	L	EC	EC	EC
TA3130-23	SCORING CRADLE ASSEMBLY, 3/16" ROLLER GAP	L	EC	EC	EC
TA3130-24	SCORING CRADLE ASSEMBLY, 1/4" ROLLER GAP	L	EC	EC	EC

CALL FACTORY FOR MORE INFORMATION

LEGEND: HP = HORSEPOWER, SD = STANDARD DUTY,
HD = HEAVY DUTY, L = LEXAN, SS = STAINLESS STEEL,
STD = STANDARD, EC = EXTRA COST, NA = NOT AVAILABLE

ALL SPECIFICATIONS CONTAINED HEREIN ARE SUBJECT TO CHANGE WITHOUT NOTIFICATION.
ITEM NO.: LIT-PRO9-131 FORM NO.: MD PRO SRS 131-10-09-32-MARK PRINTED IN U.S.A.

Service is available from over 245 locations worldwide